

# Manual Instructions

 30kg/66lbs

VESA 50/75/100/200/200x100mm

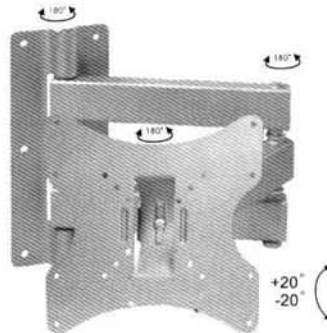

1

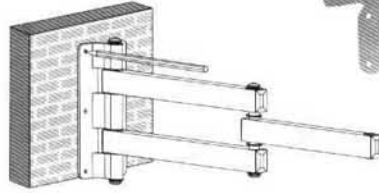

CONCRETE

2a

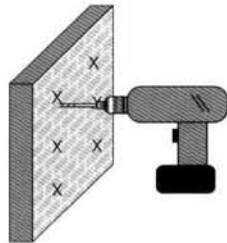

WOODEN BOARD

2b

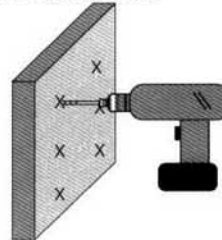

3a

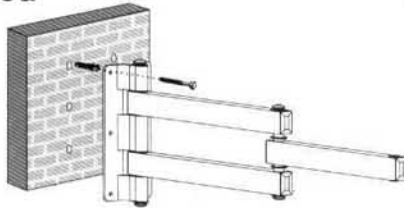

3b

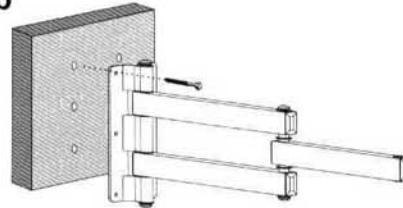

4

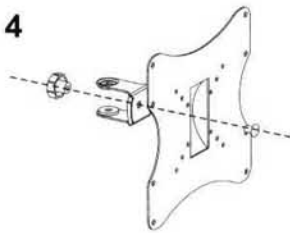

5

